



Specification

Product Name: Rifle M100 Staple Driver and Factor T Staples

1.1 Summary

- A. This specification specifies a mechanically applied erosion control anchoring device for erosion control blankets (ECB), turf reinforcement mats (TRM) and geotextiles. The mechanical device drives and guides the staple into the ground preventing the staple from bending out of shape. Once installed the staple holds the blanket in place and resists wind forces from pulling up the blanket.

1.2 Submittals

- A. Product Data: Submit manufacturer’s product data and installation instructions.
- B. Certification: Manufacturer shall certify that the product meets or exceeds all physical properties, endurance, performance and packaging requirements.

1.3 Delivery Storage and Handling

- A. Deliver material and products in waxed weather-resistant packaging that has factory labels to identify the product. Store and handle according to manufacturer’s instructions and recommendations.

Products

2.1 Product Composition/ Property Values

- A. All components of the Staples shall be prepackaged by the manufacturer to assure both material performance and compliance with the following values:

Staple dimension	6” x 1” x 6” u-shaped
Gauge	13 gauge
Stiffness	1018 or stiffer
Galvanized	NOT allowed
Number of staples per cartridge	50
Number of staples per box	1000

2.2 Packaging

- A. Rifle M100 weight = 13. kg (25lbs),
- B. Factor T box of 1000 weight: 12kg (24 lbs)
- C. Pallet Quantity: 50 boxes of staples per pallet

EXECUTION

3.1 Rifle M100 Assembly

- A. The Rifle M100 comes in a box from the manufacturer some assemble is required:
 - a. Remove the staple gun and parts from the box.
 - b. Install large compression spring on driving rod
 - c. Install handle on top of driving rod
 - d. Secure with pin
 - e. Pull back the staple pusher and load 2 cartridges of staples and release the staple pusher.

3.2 Installation

- A. *Equipment:* Contractor shall use a working mechanical staple driver that has sufficient size to install the proper size wire staple.
- B. *Application:* With two hands on the handle and the base of the gun on the blanket on the ground, push down the staple driver till the staple is fully in the ground and out of the chamber. Move the gun to the next position and repeat.
 - a. If the staple hits a stone which it can not penetrate DO NOT try to force the staple through the stone. Immediately pull the staple driver up and remove the staple from the gun or the ground and try to install another staple in a different area near by
 - b. If the ground is frozen or very firm and you can not drive the staple in one stroke, then pull the handle half way up and strike as many times as you need to complete the installation of that staple. At anytime you start to bend the staple before it is fully installed STOP and remove the staple and start with a new staple in a different area.
- D. *Application Rates:* The Following Install and Application rate chart should be used

ErosionControlBlanket.com

Installation Instructions

SLOPE APPLICATION

1. Prepare soil so that area is smooth, then add seed, fertilizer & lime as required.
2. Start by stapling the blanket at the top of the slope in a 6" deep x 6" wide (150mm x 150mm) trench. Backfill & compact trench so that the water will flow evenly onto the blanket.
- 3(a). Roll blanket down the slope, or (b) horizontally across slopes < 50 feet (16m), insuring soil blanket contact.
4. Overlap edges of blanket a minimum of 2" (50mm) with parallel blankets.
5. If more than one blanket is needed for the run then overlap adjoining ends a minimum of 4" (100mm) shingle style. Staple overlap areas with staggered pattern with staples.

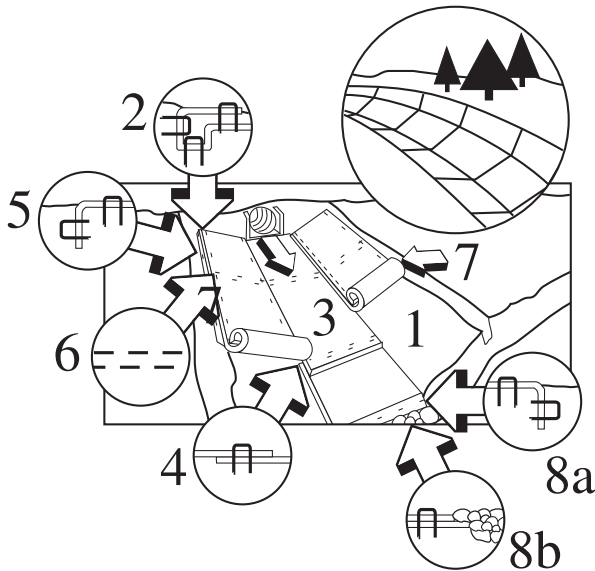
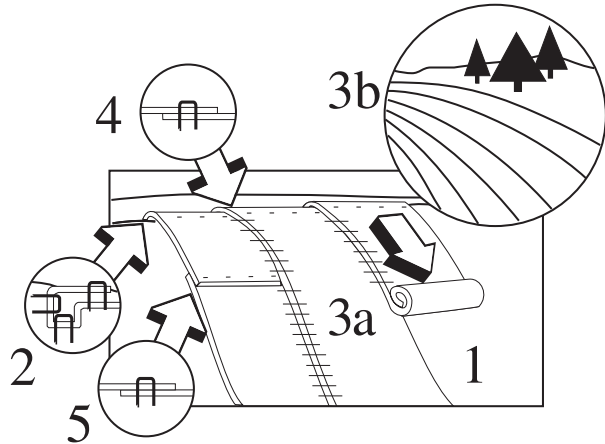

CHANNEL APPLICATION

1. Prepare soil so that area is smooth, then add seed, fertilizer & lime as required.
2. Start by stapling the blanket at the top of the channel in a 6" deep x 6" wide (150mm x 150mm) trench. Backfill & compact trench so that the water will flow evenly onto the blanket.
3. Roll center blanket in the bottom of the channel & place 4 staples (evenly spread) per square yard. Follow staple pattern on back to determine pattern for your situation.
4. Place adjoining ends (shingle style) overlapping 6" (150mm) securing the overlap with a double row of staples staggered 4" (100mm) apart. Overlap edges of blanket a minimum of 6" (150mm) with parallel blankets.
5. The full length of the blanket at the top of the channel must be anchored in a 6" wide x 6" deep (150mm x 150mm) trench then backfilled & compacted after placing staples in the trench 3 feet (1 meter) apart. Insure compacting so that water can flow evenly onto the blanket from the sides of the channel.
6. Place a double row of staggered staples 4" (100mm) apart every 33 feet (10 meters)
7. Insure blanket is placed on side banks of channel 1 foot (300mm) higher than expected water flow.
- 8(a). At the terminal end of the channel, the blanket must be anchored such that the water will flow to the desired area. If the end of the channel is a culvert, the blanket must be placed under the culvert & secured with staples 4" (100mm) apart in a staggered pattern. (b) If at the terminal end is a rock outfall, the blanket must be placed in a 6" wide by 6" deep (150mm x 150mm) trench stapled then backfilled, compacted then rocks placed on the trench to blend the two systems together.

SHORELINE APPLICATION

1. If possible lower level of water for ease of application. If water is artificially lowered before application, install blanket before water level is raised.
2. Prepare soil so that area is smooth then add seed, fertilizer & lime as required.
3. Start by stapling the blanket at the top of the slope in a 6" deep x 6" wide (150mm x 150mm) trench. Backfill & compact trench so that the water will flow evenly onto the blanket.
- 4(a). For slopes over 50 feet (16m) in length lay blanket down the slope. (b) For slopes < 50 feet (16m) you may lay the blanket horizontally along the slope.
5. Overlap the blanket 4" (100mm), staple through both blankets of overlapped area with one staple every 12" (300mm). Staple blanket at a rate of 2 staples per square yard below the highest water level.
6. The bottom end of the blanket that falls below the water level must be placed in a trench that is 12" deep and 6" wide (300mm x 150mm), stapled, backfilled, & compacted. Rocks larger than 6" (150mm) in diameter may be used instead of trenching. Actual rock size should be chosen depending on shear stress created from the water. Trenching is the more desirable method but sometimes the least practical of the two.
7. If the soil is loose, the use of longer staples may be required.

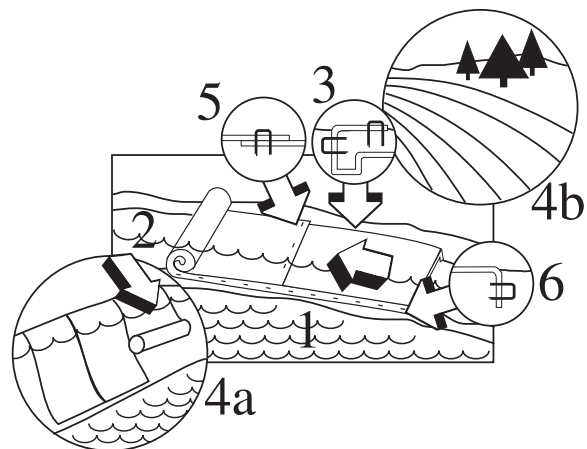

STAPLE PATTERN

1. The choice of staples depends on the compaction of the soil. In general the staples once applied should not easily come out by hand. The standard 6" (150mm) two sided staple is the norm but in sandier soils an 8"-10" (200mm-250mm) double sided may be required.
2. In extreme loose soil conditions a 18" (450mm) or longer pin with washers may be necessary to anchor the blanket.

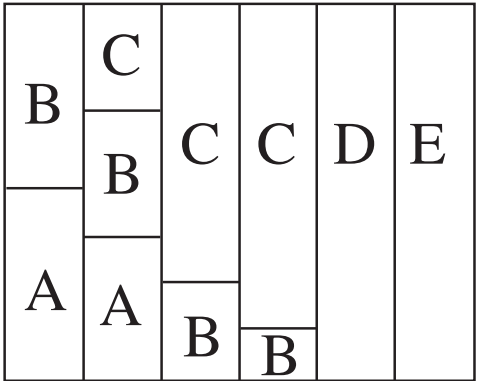
(91)	300	
(84)	275	
(76)	250	
(69)	225	
(61)	200	
(53)	175	
(46)	150	
(38)	125	
(30)	100	
(23)	75	
(15)	25	
(8)	0	
(m)	(Feet)	4:1 3:1 2:1 1:1 Low/Med Flow Channel And Shoreline High Flow Channel And Shoreline

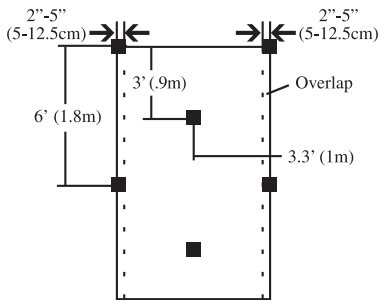

A
 .7 staples per square yard
 (.8 staples per square metre)

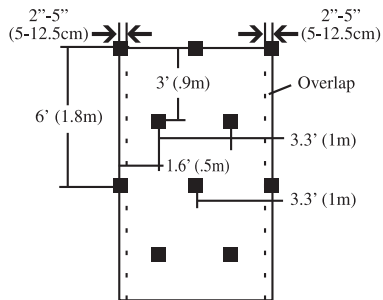

B
 1.1 staples per square yard
 (1.3 staples per square metre)

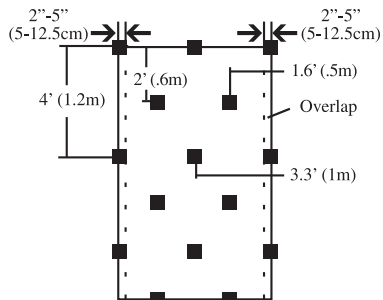

C
 1.7 staples per square yard
 (2 staples per square metre)

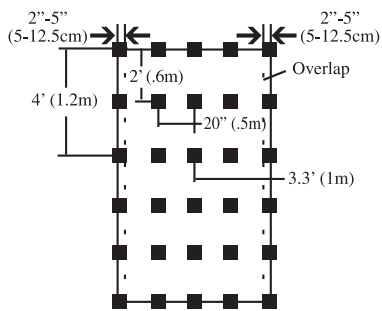

D
 3.4 staples per square yard
 (4.1 staples per square metre)

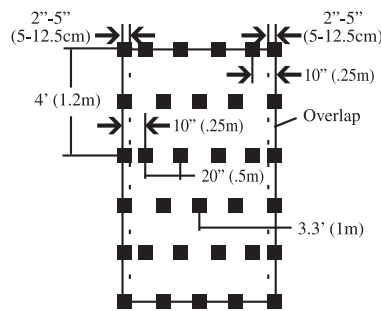

E
 3.7 staples per square yard
 (4.4 staples per square metre)



3.3 Cleaning and Maintenance

- A. Clean the Staple Driver of any mud, dirt and debris at the end of each day or as often as required.
- B. Lubricated the moving parts with dry graphite type spray on lubrication.
- C. Replace worn or broken parts as required

Copywrite 2013 ErosionControlBlanket.com, Inc. All Rights Reserved. A copyright licenses to reproduce this specification is hereby granted to non manufacturing designers, engineers, landscape architects and specification writers. February 2013.